



Electronic Service Manuals

This electronic document is provided as a service to our customers. We do not create the contents of the information contained in this document. Should you have detailed questions pertaining to the information contained in this document, you may contact Michco, or the manufacturer which provided the original information in this electronic deliverable. Michco's only part in this electronic deliverable was the electronic assembly process.

You may contact Michco through the following methods:
Phone (517) 484-9312 or (800) 331-3339 MI, OH, IN only
2011 N. High St. -- Lansing, Michigan -- 48906
Fax: (517) 484-9836
Email: CustServ@Michco.com
Web site: www.Michco.Com
Parts Web site: www.FloorMachineParts.Com

Order Parts on Line at:
www.FloorMachineParts.Com

Directly to Parts & Service:
By Email: **Shop@Michco.com**
By Fax: (517) 702-2041
By Voice: Use numbers above.

Serving the Cleaning Industry Since 1922

Notice: All copyrighted material remains property of original owners, all trademarks are property of respective owners. Manuals are subject to Manufacturer's reproduction limitations. Originals or reproductions were provided by manufacturers through a request. We make no warranty as to the correctness of information provided in this document and you assume all risk.



KENT

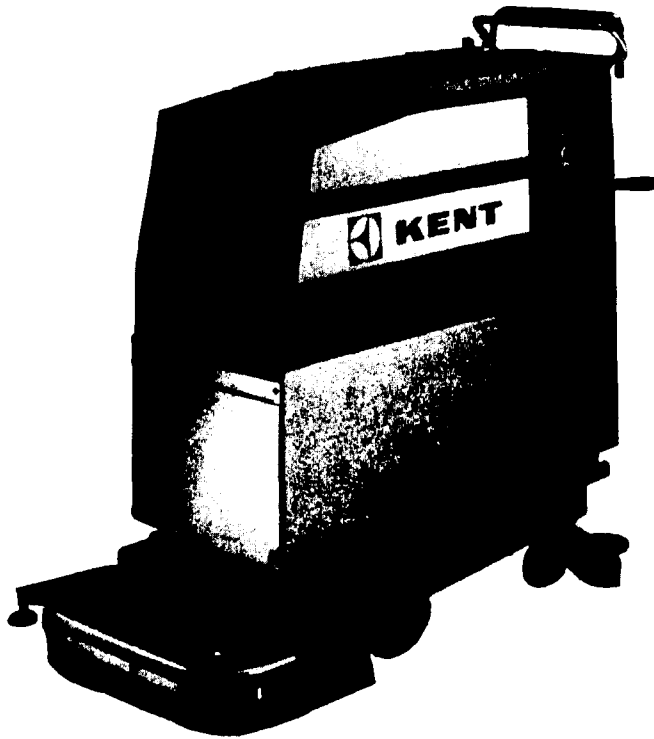

AUTOMATIC SCRUBBERVAC
MODEL: **KA-201BST**

**OPERATING,
MAINTENANCE
INSTRUCTIONS
& ILLUSTRATED
PARTS LIST**

THE KENT COMPANY
2310 INDUSTRIAL PARKWAY
P.O. BOX 1665
ELKHART, IN 46515
FAX: 219-295-8610
WATS: 800-334-1083 (OUTSIDE INDIANA)
219-293-8661

JULY 1988

MACHINE SPECIFICATIONS:

CONTROLS.....	Light effort push/pull for forward or reverse operation. All switches, manual water control, and manual brush lift lever easy to reach, hand operable.
TRACTION MOTOR.....	24V, 1/2HP 1200 RPM Permanent Magnet type.
VACUUM MOTOR.....	24V, 3/4HP, 2-stage bypass type.
BRUSH DRIVE MOTOR.....	24V, 1/2HP, 1200 RPM Permanent Magnet type. Belt Drive to self-leveling brushes.
TRACTION DRIVE.....	Slipping belt thru chain to differential.
BRUSHES.....	Dual 10-1/2" (26.7cm) dia., self-leveling counter-rotating, 280 RPM.
SCRUBBING WIDTH.....	20" (50.8cm).
BRUSH PRESSURE.....	52 lbs. (23.6kg) in float position 91 lbs. (41.3kg) in strip position
TANKS.....	11.5 gal. (43.5L) capacity each, high density, molded seamless linear polyethylene.
BATTERIES.....	Four heavy-duty deep cycle type, 6V, 200 AH series connected.
SQUEEGEE.....	23" (58.4cm) wide, swinger type with gum rubber blades and arcuate shape.
WHEELS.....	Two 8" (20.3cm) dia. polyurethane wheels - front Two 3-1/2" (8.9cm) dia. polyurethane swivels - rear
SOLUTION FEED.....	Adjustable flow rate to center of each brush.
FRAME.....	All welded stainless steel, 1/4" (0.6cm) flat bars, and 11 Ga. (0.3cm) thick plate.
OUTER SHELL.....	All exterior panels 16 Ga. brushed stainless steel.
BRUSH COVER.....	Aluminum casting with rubber bumper wheel and splash guard.
BATTERY CHARGER.....	Exterior - Electronic, 20 Amp, 24V
LENGTH (OVERALL).....	48" (121.9cm)
HEIGHT (OVERALL).....	41-1/2" (105.4cm)
WIDTH (BODY).....	15-1/4" (38.7cm)
WIDTH (BRUSH COVER).....	23" (58.4cm)
WIDTH (SQUEEGEE).....	23" (58.4cm)
WEIGHT (MACHINE W/BATTERIES).....	526 lbs. (238.7kg)
WEIGHT CHARGER.....	22 lbs. (9.9kg)
SHIPPING WEIGHT (TOTAL).....	632 lbs. (286.8kg)

THE KENT CO.		
ELKHART, INDIANA USA		
SERIAL NO	MODEL	
VOLTS	PHASE	Hz
MOTOR 1	A.M.P.	H.P.
MOTOR 2	A.M.P.	H.P.

The model, type and serial number are indicated on the data plate. For prompt and complete information, always refer to these numbers when inquiring about service.

WRITE THE MODEL AND SERIAL NUMBER OF YOUR UNIT IN THE SPACE PROVIDED. REFER TO THE DATA PLATE ON UNIT.

MODEL # _____ SERIAL # _____
 RETAIN THIS OWNER'S GUIDE FOR FUTURE REFERENCE.

AUTOMATIC SCRUBBER ACCESSORIES	
PADHOLDER.....	20345
PADHOLDER SERVICE PARTS:	
— CENTER PLATE (ATTACHED).....	38881
— CLAMPING PLATE (LOOSE).....	38882
STRIP PAD.....	15653
SCRUB PAD.....	15654
POLISH PAD.....	15655
SCRUB BRUSH.....	20257
POLISH BRUSH.....	20258
NYLON BRUSH.....	20270
STEEL WIRE BRUSH.....	20280
KEN-GRIT BRUSH.....	20296
MICROSTAT FILTER KIT.....	38303
FILTER BAG (DRY PICKUP ONLY).....	47351
SLUDGE TRAP (WET PICKUP).....	49844
BATTERY:	
— WET.....	26408
— DRY.....	26441
CHARGERS:	
— 120V 60HZ.....	31355
— 100V 50HZ.....	31356
— 230V 50HZ.....	31357
— 230V 60HZ.....	31359
KEYLOCK SWITCH.....	38373
NEOPRENE SQUEEGEE BLADE.....	50026
FELT SQUEEGEE (DRY PICKUP).....	32171

INTRODUCTION

Your automatic has been especially engineered and manufactured to give the maximum in performance during scrubbing and polishing of large floor areas.

With careful maintenance according to the instructions outlined in the following pages, a high standard of operation throughout its use will be insured.

Carefully inspect all components to insure that there is no concealed freight damage. If such damage is discovered, file a "CONCEALED DAMAGE REPORT" immediately with the delivering carrier.

The contents of this manual are based on the latest product information available at the time of publication. The right is reserved to make changes at any time without notice, in materials, equipment, price, color, specifications and models.

IMPORTANT SAFEGUARDS: ACCIDENTS DUE TO MISUSE CAN ONLY BE PREVENTED BY THOSE USING THE MACHINE. TO GUARD AGAINST INJURY, BASIC SAFETY PRECAUTIONS AS SHOWN IN THIS MANUAL SHOULD BE OBSERVED.



CAUTION: READ AND FOLLOW ALL SAFETY INSTRUCTIONS.

CONTROL PANEL

1. Red light indicates that the main drive motor switch is "ON".
2. "ON/OFF" switch for VACUUM motor.
3. Battery meter. The needle must be within the GREEN area for efficient operation.
4. Main DRIVE "ON/OFF" switch.
5. Water flow control knob.

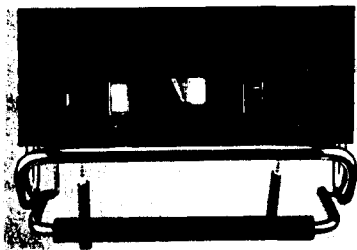

MOTOR PROTECTION

There are two circuit breakers located on the lower part of the right collar of the machine. These circuit breakers protect the motors in your machine by shutting them off in the event that they become overheated during operation. There is one circuit breaker to protect the brush drive motor and one to protect the traction drive motor. If either of these motors will not turn on during operation, check to see if one of the circuit breaker buttons has popped out. If so, once the motor has been allowed to cool for a moment, push the button in and resume operation.

TRACTION DRIVE OPERATION

To move the machine in forward or reverse first push the drive switch "ON." The forward motion of the machine is controlled by squeezing the control bar lightly for creeping motion, firmly for full speed. Reverse motion is controlled by pulling the control rod backwards, again lightly for creeping action, firmly for full reverse speed. The machine is equipped with a differential drive for easy turning in either direction.



SQUEEGEE OPERATION

On the rear panel, the right handle raises and lowers the squeegee. To raise the squeegee, push the handle down and set it on the bottom of the ramp.

Pull the squeegee handle up to lower the squeegee. This automatic is equipped with a squeegee which is capable of swinging three (3) inches to either side of the machine. This permits picking up of water on a turn because the squeegee will follow the pattern of the brushes. When up against a wall, the squeegee will ride tight to it until the machine pulls away. Should the squeegee encounter an obstruction, it will shift laterally until the obstruction has been passed.

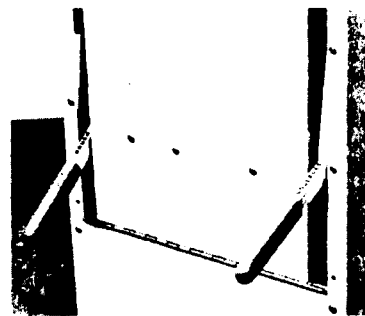

BRUSH CONTROL

To start and lower brushes:

1. Push drive switch "ON."
2. Pull the left handle up for scrubbing operation.
3. For heavy scrubbing and stripping operations, pull all the way up and set it on the top of the ramp.

INSTALLING THE BRUSHES



PLACE MAIN SWITCH IN OFF POSITION BEFORE APPROACHING BRUSH COVER.

The automatic comes equipped with two scrub brushes which mount to the brush drive as follows: Each brush has three (3) lugs located around a hole. Under the cast aluminum brush cover are two drive plates (B); each has three (3) slotted holes to accept the brush lugs. In the center of each drive plate is a hub which will fit into the hole in the brush.

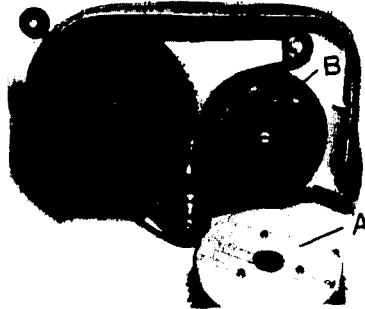

TO INSTALL BRUSHES:

1. Place Master Switch in "OFF" position.
2. Raise the brushes by pushing the brush handle down. (Fig.A)



Fig. A

Fig. B

3. Open lower front lid by backing out two wing bolts. (Fig.B)
4. Pull out ring pins connected by cable to machine, one on each side of machine. (Fig. C)

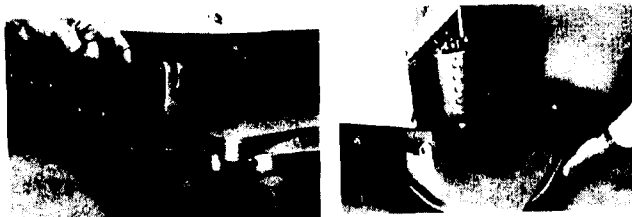

Fig. C

Fig. D

5. Open front lid and pull the Brush Head Assembly forward about 5-1/2 inches. (Fig.D)
6. Tilt brush head up, reach under machine and move slide bar assembly, located underneath forward part of machine chassis, forward to "hold" assembly in that position. (Fig.E)
7. Re-insert one ring pin to prevent Head Assembly from going back into operating position.

Unit is now ready for brush or pad change or, if necessary, brush drive belt adjustment (see Adjustments).

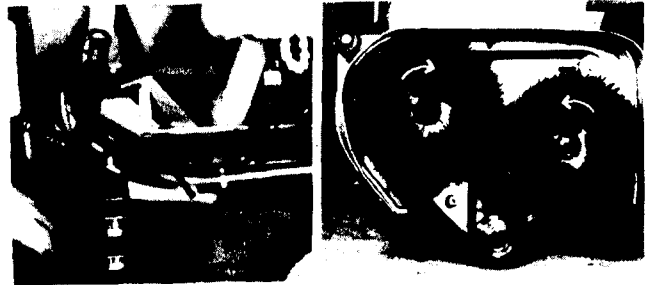

Fig. E

Fig. F

8. To remove brushes, grasp bristles and with a sharp jerk, rotate brushes as shown. (Fig.F)

To re-install brushes, reverse above procedure.

To re-assemble brush head into machine for operation:

1. Remove ring pin
2. Move slide bar backward
3. Tilt brush head down
4. Slide brush head backward into position
5. Re-insert two ring pins
6. Close front lid using two wing nuts

NOTE: This unit is equipped with a safety switch that disconnects the electrical system when the brush head assembly is out of operating position, making the main switch inoperable.

SOLUTION TANKS

The fresh solution and recovery tanks are mounted side by side in front of the control panel. Both tanks are made of Linear Polyethylene. The right tank is for fresh solution and is marked "FILL HERE". The left tank is the recovery tank with built-in automatic float shut-off for vac motor protection. This tank can be quickly converted for dry use by inserting a cloth bag (Part No. 47351) over the tank inlet tube inside the recovery tank. For dry use operation, replace wet squeegee with a dry felt squeegee (Part No. 32171) and the brushes can be changed to Polish (No. 20258) or Pad Holders (No. 20345).

To fill the fresh solution tank, raise the machine lid and remove the solution tank lid. Pour solution into tank opening with care to avoid sloshing over machine. Mix solution to be used according to the manufacturer's directions for the particular application and chemicals.

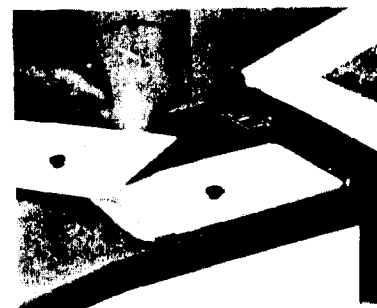

Fill the solution tank with the desired amount of solution.

NOTE: DO NOT USE HOT WATER (OVER 125 DEG.F/ 51 DEG.C) IN EITHER TANK.

VACUUM MOTOR AND LINT FILTER

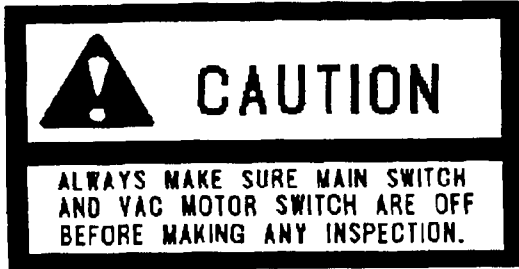

The vacuum motor is located in the rear behind the recovery tanks, and can be inspected by lowering the rear access panel and removing the wing nuts which secure it to the mounting bracket. If the vacuum motor requires removing for repairs:

1. Disconnect and remove one of the battery cables being careful not to allow it to touch any of the other battery terminals.
2. Disconnect the electrical wire nuts fastening the vacuum motor leads.
3. Remove the motor filter, clean the foam material.
4. Reverse the above procedure for re-assembly.

MICROSTAT FILTER

(Optional) Package of 12 (Part 38303)
Installation:

1. Remove the vacuum motor by lowering the rear access panel and removing the wing nuts which secure it to the mounting bracket.
2. Place the Microstat Filter into the vacuum motor mounting bracket. Be sure to cover the entire gasket that is on the bottom of the mounting bracket. Replace and secure the vacuum motor.
3. Replace Microstat Filter every two weeks under heavy use.

SCRUBBING OPERATIONS

To apply solution to the floor, scrub and immediately recover the liquid and soil, the following sequence of operations is followed:

1. Press the main drive switch to the "ON" position.
2. Turn the vacuum switch "ON."
3. Lower the squeegee.
4. Turn water knob to desired flow rate.
5. Lower the brushes to the desired position; brush drive motor automatically turns "ON."
6. Squeeze the control rod for forward motion. Various speeds of forward or reverse motion can be obtained by changes in force on the central rod. An infinite number of speeds are available. **DO NOT REVERSE MACHINE WITH SQUEEGEE DOWN.**

TURNS IN THE NORMAL SCRUBBING PATTERN

In order to reduce an over abundance of solution during operation on sharp turns:

- (A) Turn water knob to "OFF" six (6) feet before the turn.
- (B) Return the water knob to "ON" in the middle of the turn.

Our automatics can be easily controlled and maneuvered with one hand leaving the other hand free to manipulate the water flow.

TO DUMP SOLUTION

1. Open lower front access panel and remove slide valve assembly from compartment.
2. Point dump hose into drain and away from you before pulling slide, solution will dump very fast.
3. Reverse procedure when recovery tank is empty.



MACHINE CARE

Please read and follow the daily, weekly, and monthly maintenance schedule located on THE UNDERSIDE OF THE LID OVER THE BATTERY COMPARTMENT.

At the end of the day's operation, the machine should be completely cleaned and prepared for the next shift's operations. Careful maintenance will insure effective performance throughout a long period of service.

1. Open the access to the recovery tank and completely rinse with clean water. If this is done at the end of each day, there will be no soil build-up to the surface of the polyethylene tank.
2. Clean the fresh water tank using the same procedure as in No. 1 above.
3. Do not store the machine with the brushes in down position because of the possible set in the brushes and possible discoloration of the floor due to moisture in the brushes.
4. Tilt the tanks full forward and inspect the battery compartment to insure that no large amount of water or solution has gathered in the battery compartment tray.
5. Remove the brushes from the machine; clean and dry them as necessary and wipe down exterior of the machine.

MAINTENANCE INSTRUCTIONS

A sound preventative maintenance program will insure long, reliable and effective performance from your machine. We would strongly suggest that responsibility for the machine be assigned to a reliable individual in your organization.

DAILY

1. Clean and flush fresh and recovery solution tanks.
2. Clean lint filter on vac fan.
3. Wipe squeegee blades and machine wheels clean.
4. Wipe clean all interior and exterior surfaces.
5. Check battery water level and clean tops with damp cloth - connect battery charger.
6. Charge batteries.
7. Check pick-up tube for any obstruction.

WEEKLY

1. Lubricate chain and check for tension.
2. Lubricate all linkage and hinge parts. See lubrication chart.
3. Lubricate caster bearings and axle. See lubrication chart.
4. Replace Microstat Filter (where applicable).

MONTHLY

1. Check belts and chain for tension and wear. (See adjustments.)
2. Check sprockets for wear.
3. Check alignment of chain and belts.
4. Check all gaskets, vacuum motor, tank inlet tube, and water valve.
5. Check traction bar control spacing.
6. Check all wiring connections for cleanliness.

SIX MONTHS

1. Inspect vacuum motor carbon brushes, replace if worn to 3/8" (10mm) length or less.
2. Inspect traction motor carbon brushes, replace if worn to 3/4" (19mm).
3. Inspect brush drive motor carbon brushes, replace if worn to 3/4" (19mm).

ADJUSTMENTS

SQUEEGEE PRESSURE

Pressure to the floor is adjusted by increasing or decreasing spring tension. To increase pressure, turn the hex nuts (A) immediately above the springs clockwise. To decrease the pressure, the nuts should be turned counterclockwise.

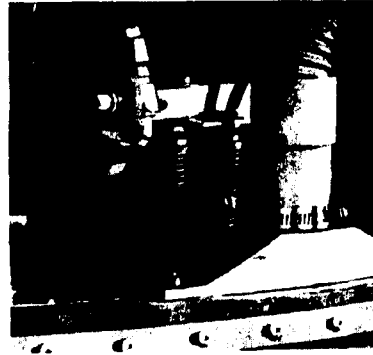

TRACTION DRIVE BELT TENSION

Tighten belt by loosening nuts "A" (in photo), moving arm "B" up, and re-tightening the nuts. If after adjustment the automatic starts with a sudden jerk, arm "B" has been moved too high. Loosen nuts "A", lower arm "B", tighten nuts and operate your automatic.



BRUSH DRIVE BELT TENSION

Adjust by loosening the idler pulley bolt located on left front of brush cover as shown. Slide the bolt as required for proper belt tension, then tighten the bolt securely. If unsatisfactory brush rotation continues, see Brush Motor Belt Tension (below).



BRUSH MOTOR BELT TENSION

Adjust by removing cover from brush head, loosen motor hold down bolts and turn bolts clockwise to tighten motor drive belt.

CONTROL BAR SWITCHES

The traction drive motor in this automatic scrubber is controlled by two switches which are activated when the control bar is squeezed tight or pulled back. These switches are triggered by cams which are mounted to the activator pivot linkage. The adjustment of these cams on the pivot linkage and the mounting position of the switches must be correct in order for the traction drive motor to function properly.

To adjust the switches and cams:

1. Turn all switches off.
2. Open rear access door.

The switches and cams are located about 2 inches forward and 1 inch beneath the water control knob. The switches are mounted together under the pivot linkage. The switch nearest the center of the machine is the traction motor ON/OFF switch. Adjust this switch first. To adjust:

(A) Loosen the set screw on the cam nearest the center of the machine. The cam has a V-groove on one side. With the control bar released in neutral position, this cam should be directly above the switch and the V-groove should be down so that the switch roller rests in the center of the groove (see Figure). With the cam in this position tighten the cam set screw.

Cam-Switch Configuration with Control Bar in Neutral Position

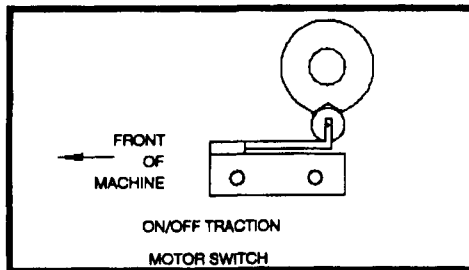

(B) The mounting position of the switches must be at a height which allows the operator to move the control bar about 1/2-3/4 inch in both forward and reverse before the ON/OFF switch (the switch nearest center of machine) is activated. An audible click occurs when the switches activate. If this height is not correct, loosen the switch mounting screws and move the switches up or down until the ON/OFF switch is set correctly. After this is set, check to make sure the roller rests in the center of the cam V-groove when the control bar is in the neutral position.

3. The left cam activates the forward-reverse traction motor switch. This cam should be set so that even the slightest backward movement of the control bar will activate the forward/reverse switch. When the control bar is pulled back from the neutral position this switch **MUST** activate before the ON/OFF switch (referred to above) activates. If it doesn't, loosen the left cam set screws and index it on the shaft to the correct setting (see Figure). Then retighten the cam set screw. In some cases it may be necessary to bend the switch lever.

Approximate Cam switch Configuration with Control Bar in Neutral Position

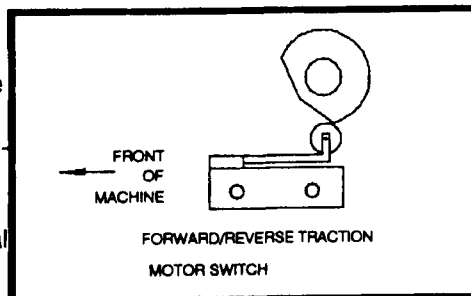

USE OF THE BATTERY CHARGER

GROUNDING INSTRUCTIONS

The Charger should be grounded while in use to protect the operator from electrical shock. The Charger is equipped with suitable three-conductor cord and 3-prong grounding-type receptacle. The green (or green and yellow) conductor in the cord is the grounding wire. Never connect the green (or green and yellow) wire to a live terminal. If your unit is for use on less than 150 volts, it has a plug that looks like Figure A. If it is for use on 150 to 250 volts, it has a plug that looks like Figure C. An adapter, Figure B, is available for connecting Figure A plugs to 2-prong receptacles. The green (or green and yellow) grounding wire extending from the adapter must be connected to a permanent ground such as to properly grounded outlet box. No adapter is available for Figure C plugs.

Use only three-wire extension cords which have 3-prong grounding-type plugs and 3-prong receptacles that accept the appliance's plug. Replace or repair damaged cords.

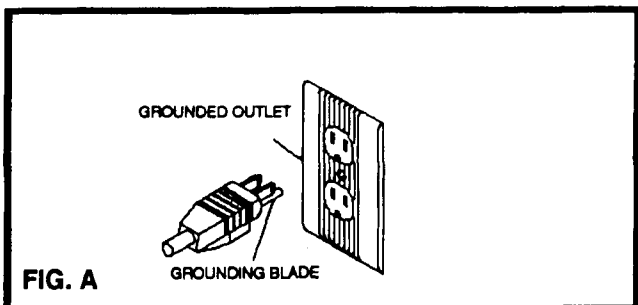

FIG. A

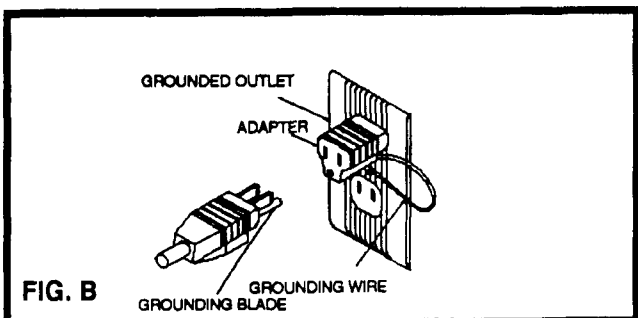

FIG. B

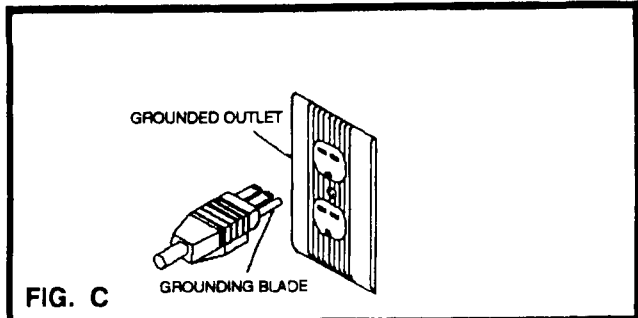

FIG. C

The Battery Charger is electronically controlled and will drop and hold a finish rate of 2-3 amps at which time the charger will stay on for another 2 hours before stopping. Timer often will not go to zero or OFF. The charger is equipped with a standard 15 amp fuse for protection from short circuit or reverse polarity of the batteries.

To operate the battery charger:

1. Lift the lid of the Automatic and tilt the solution tanks full forward.

2. Connect the charger plug into the machine plug firmly. The charge plug is mounted on the partition between the brush drive motor and dump hose. **DO NOT LOWER SOLUTION TANKS.**

3. Plug the battery charger into a normal grounded electrical outlet and turn the timer to "ON."

Hydrogen gas is formed when the batteries approach the full charge state. This gas is explosive;



CAUTION:

therefore, when charging batteries with lid open, avoid any open flame or electric spark near batteries. This includes connecting or disconnecting charger with timer "ON." To avoid accumulation

of gas, be sure batteries receive good air circulation while being charged.

NOTE: Set the battery charger on a flat, hard surface to insure that cooling air can circulate through the bottom louvers.

The battery charger is guaranteed against defective parts and workmanship. Any parts proving defective within six months will be repaired free of charge when the charger is returned prepaid to the manufacturer.

BATTERY CARE

Battery care determines the life span and efficiency of the units. Therefore, for the longest possible useful life from these batteries, the following procedure should be followed:

1. Keep battery solution (electrolyte) level up in cells. Check daily - if cells need water, use only distilled or approved water.

2. Keep batteries fully charged.

3. Keep batteries and connection clean. When necessary, clean with baking soda solution, attach wires and coat terminals with grease to retard corrosion.

SERVICE & BATTERY GUARANTEE APPLYING TO SCRUBBER-VAC BATTERIES

SERVICE GUARANTEE: If a battery becomes unserviceable in normal use within 90 days of purchase, the purchaser is entitled to a new battery of a comparable size and type, without charge, or to the necessary repairs, without charge for either labor or materials, at the option of the manufacturer. Transportation, recharges, or the use of rental batteries are not classed as repairs and the battery owner is expected to pay for such services, if required.

ADJUSTMENT POLICY: If a battery becomes unserviceable in normal use after the expiration of the service guarantee, it will be repaired or replaced with another battery of a comparable size and type to the original purchaser, on a pro-rated price basis, in exchange for the unserviceable battery, the purchaser paying only for the service received, plus transportation charges.

LIMITATIONS: Failure in service due to fire, wreckage, explosion, freezing, abuse or neglect, use of battery "dopes," or the use of a battery of a group size smaller than of the battery used as original equipment is not covered by the Service & Battery Guarantee. The Service & Battery Guarantee will not apply if battery has been opened or repaired or manufacturer's identification markings has been obliterated before presentation for adjustment or if battery has broken case or cover or if battery is discharged.

SCALE FOR PRO-RATING AFTER 90 DAYS

Months Operation Price Exchange
Months Guarantee x 1 = Price

All batteries are guaranteed for twelve (12) months from date of receipt.

(Subject to change without notice)

SERVICE DIAGNOSIS - TROUBLESHOOTING CHECKLIST

PROBLEM

CORRECTION

MACHINE WILL NOT MOVE

1. Loose wire.
2. Battery condition low.
3. Safety switch cutting out.
4. Drive belt slipping.

1. Reconnect.
2. Check voltmeter and charge batteries.
3. Install brush head completely.
4. Tighten belt. See section on drive belt tension.

BRUSH DRIVE MOTOR WILL NOT START

1. Brush Drive Switch faulty.
2. Loose wire.
3. Battery condition low.
4. Circuit breaker tripped.

1. Replace switch.
2. Reconnect.
3. Check voltmeter and charge batteries.
4. Reset by pushing circuit breaker button.

MACHINE STREAKING A CLEANED FLOOR

1. Foreign materials lodged under rear squeegee blade.
2. Insufficient water flow to brushes.
3. Worn squeegee blades.
4. Worn brushes or pads.
5. Improper squeegee adjustment.

1. Raise squeegee and clean squeegee blade.
2. Clean screen and fresh solution tank and eliminate any restrictions in lines.
3. Replace squeegee blade
4. Replace brushes or pads.
5. See Squeegee Adjustments.

VACUUM SUCTION BLOCKED

1. Clogged pick-up tube.
2. Lint Filter dirty.
3. Air leaks around vac motor.
4. Clogging at elbows and hose entering recovery tank

1. Remove accumulations.
2. Clean lint filter.
3. Examine gasket for damage.
4. Lift open tanks, remove hose and clean.

SHORT OPERATING TIME

1. Battery charge condition very low.
2. Constant scrub operation in high pressure (strip) position.
3. Corroded wires or connectors.

1. Recharge batteries fully before beginning operation.
2. Use high pressure more sparingly.
3. Clean thoroughly.

CIRCUIT BREAKER KEEPS TRIPPING

1. Pads or brushes rubbing.

1. Install original equipment accessories.

WATER WILL NOT COME ON

1. Water line disconnected.
2. Cable is loose on water valve.

1. Reconnect water solution line to brush head.
2. Tighten cable to valve.

MACHINE PULLS TO ONE SIDE

1. Castor wheel dragging.
2. Wheel bearing dragging.

1. Replace defective castor.
2. Replace wheel bearing.

SQUEEGEE LEVER DOES NOT PICK UP

1. Squeegee cable broken.
2. Squeegee height requires adjustment.

1. Replace defective cable..
2. See adjustment instructions in manual.

CHARGER WILL NOT COME ON

1. DC or AC cords not connected.
2. Fuse defective.
3. Polarity reversed

1. Connect.
2. Replace fuse with standard 15 Amp fuse.
3. Change polarity so voltmeter on instrument panel reads correctly.

CONTROL BAR WON'T RETURN TO NEUTRAL

1. Return spring disconnected.
2. Return spring stretched or missing.

1. Reconnect spring.
2. Replace spring.

LUBRICATION CHART

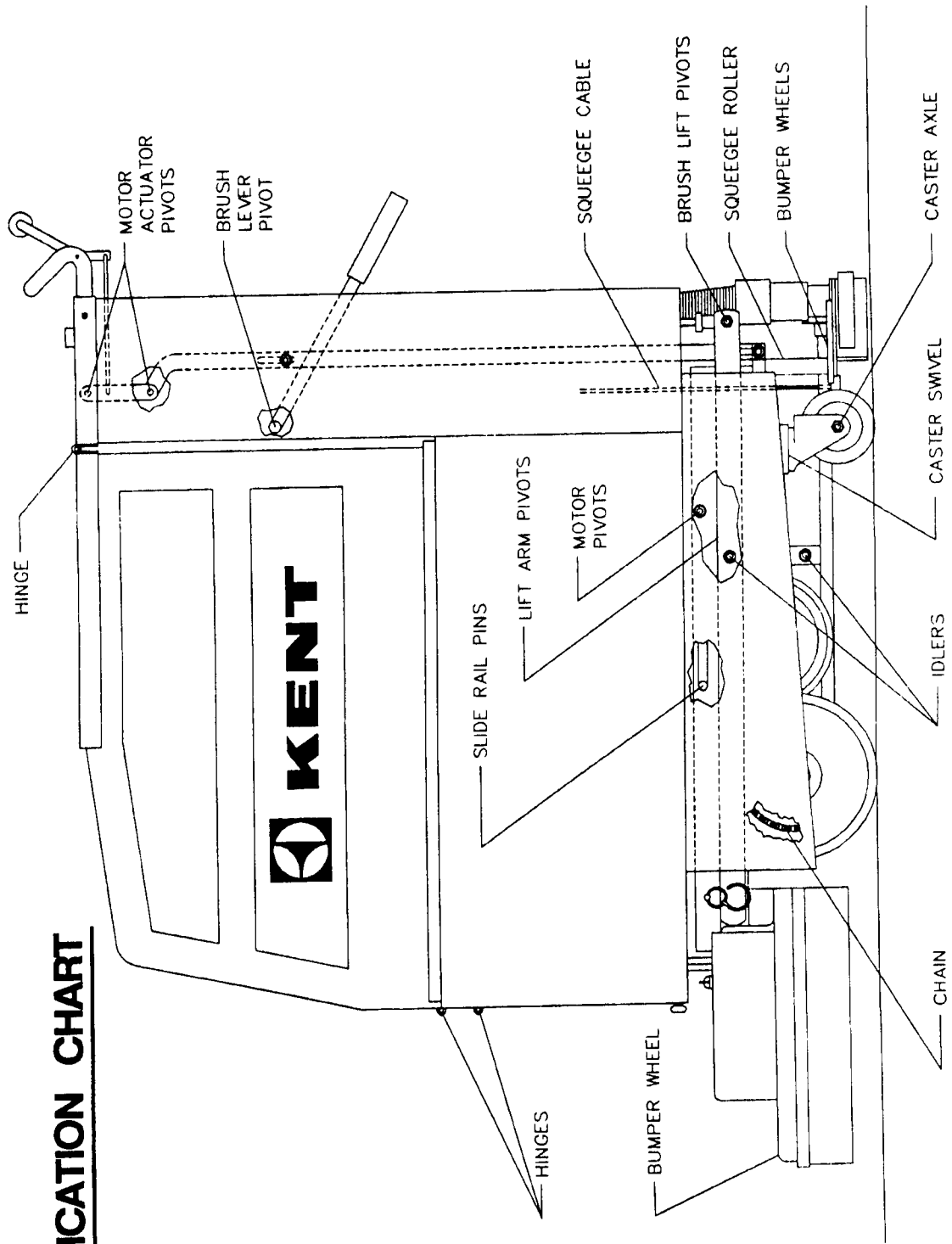

WIRING DIAGRAM

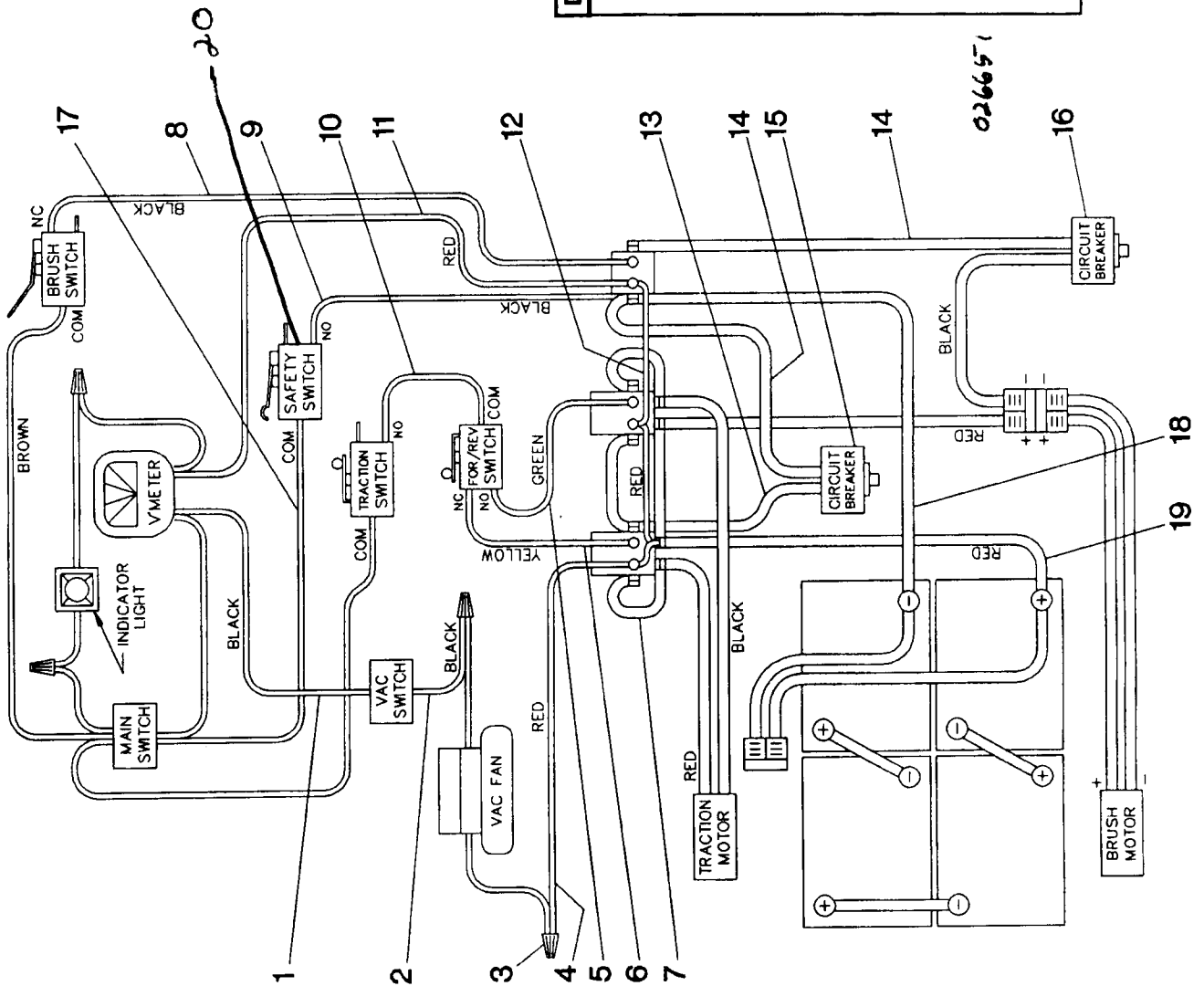

DET PART NO.	DESCRIPTION	QUANT.
1	ASM, WIRE-3 CNDCT, 16GA, BLK	1
2	ASM, WIRE-16GA, BLK, 41.0L, QD	1
3	NUT, WIRE-IDEAL 738	4
4	ASM, WIRE-16GA, RED, 19.0L, RING	1
5	ASM, WIRE-16GA, GRN, 41.0L, COMB	1
6	ASM, WIRE-16GA, YEL, 41.0L, COMB	1
7	ASM, WIRE-6GA, BLK, 10.2L, RINGS	7
8	ASM, WIRE-16GA, BLK, 15.0L, RINGS	1
9	ASM, WIRE-16GA, BLK, 22.9L, COMB	1
10	ASM, WIRE-16GA, WHT, 6.00, QD'S	1
11	ASM, WIRE-2 CNDCT, 16GA, RED	1
12	ASM, WIRE-3 CNDCT, 16GA, RED	1
13	ASM, WIRE-6GA, BLK, 14.0L, RINGS	1
14	ASM, WIRE-6GA, BLK, 5.5L, RINGS	2
15	CIRCUIT BREAKER-30 AMP, THRM	1
16	CIRCUIT BREAKER-30 AMP, THRM	1
17	ASM, WIRE-3 CNDCT, 16GA, BLK	1
18	ASM, WIRE-6GA, BLK, 14.0L, RINGS	1
19	ASM, WIRE-6GA, RED, 18.0L, RINGS	1

16 026717 Circuit Breaker -- 35 Amp, THRM
 20 026515

Master Link 048247 (43)
 1/2 Link 048336 (93)

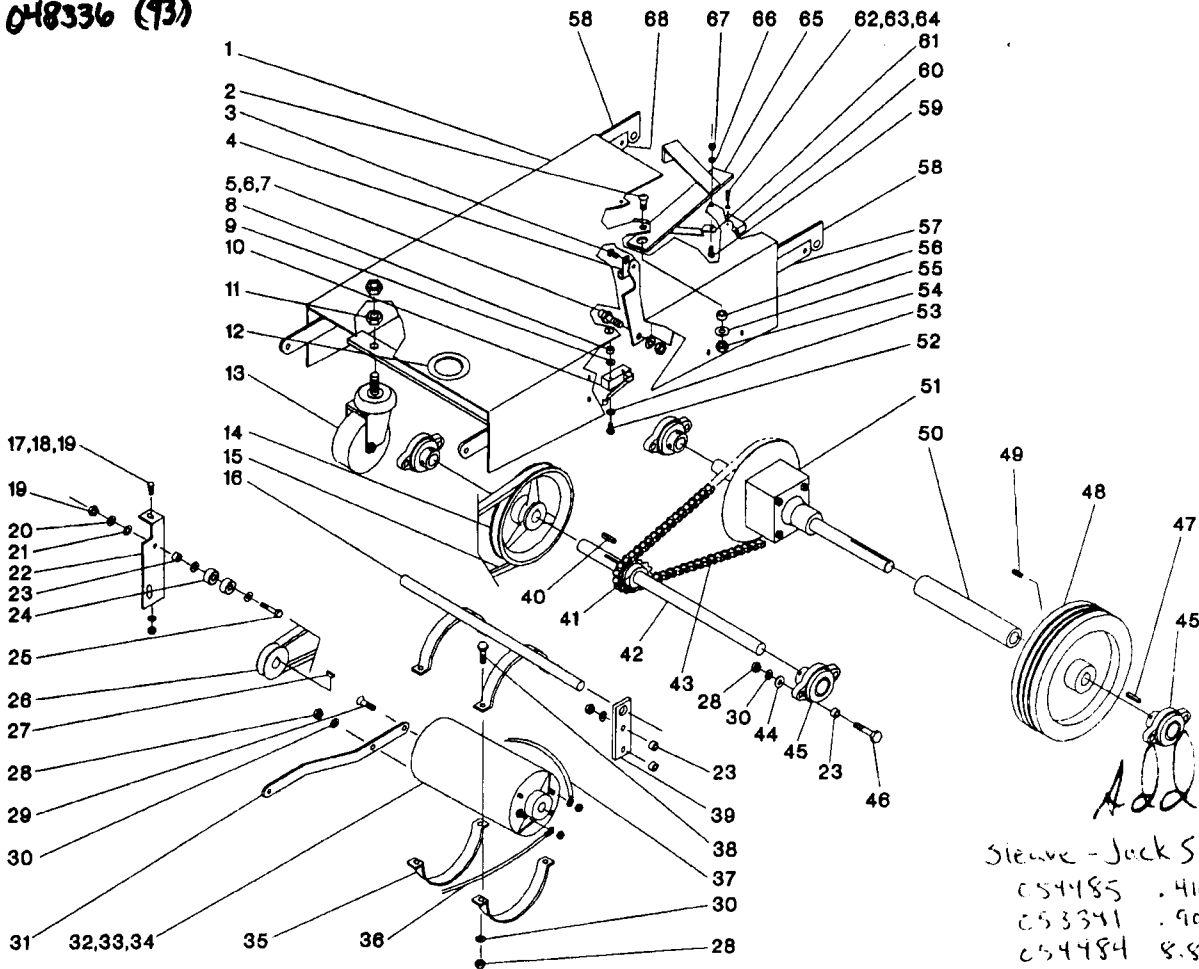

Add
 Steave - Jack Shaft (42)
 C54185 .410 L
 C53341 .900 L
 C54484 8.52 L

DET	PART NO.	DESCRIPTION	QUANT.
1	033568	WDMT,FRAME--SST,20",BTTRYAUTO	1
2	002384	SCR MACH BTN HD .375-24X.750L	1
3	005477	SCR TPG F WSH HD .250-20X.625L	1
4	049452	CABLE CLAMP-SQUEEGEE	1
5	048953	BALL JOINT	1
6	004214	WSHR LK .390ID.683OD.094TSPLT	1
7	003359	NUT,HEX--.375-24,ZN PLT	1
8	052225	SPACER,PHEN-.250X.500,.562L	2
9	004309	WSHR FLT .156ID.375OD.065T STL	2
10	026682	SWITCH	1
11	003367	NUT,HEX LOCK--.500-20,ZN PLT	4
12	050760	GROM-1.00 ID,1.25 MHD.,125 PA	1
13	049376	CASTER WHEEL	2
14	049379	SHEAVE-JACKSHAFT	1
15	049384	BELT,V-4L,23.00 PITCH LENGTH	1
16	032818	ASM,PIVOT-MOTOR MOUNT	1
17	002256	SCR CAP HEX HD .250-20X1.00L	1
18	002278	WSHR LK .262ID.489OD.062TSPLT	1
19	003283	NUT,HEX--.250-20,ZN PLT	3
20	004254	WSHR LK .267ID.510OD.028T EXT	2
21	004208	WSHR FLT .281ID.500OD.036T STL	6
22	032819	ASM,GUARD-BELT	1
22	049415	BRACKET-BELT DRIVE	1
23	049377	SPACER,STL--.315X.500,.280L	2
24	E47788	BRG,BALL-.250ID.,.688OD.,.312W	4
25	002267	SCR CAP HEX HD .250-20X1.50L	2
26	049385	SHEAVE-MOTOR	1
27	049017	KEY,WOODRUFF--#606,.750D.,.187W	1
28	003378	NUT,HEX LOCK--.312-18,ZN PLT	17
29	002297	SCR MACH FLAT HD .312-18X.625L	1
30	004212	WSHR LK .326ID.586OD.078TSPLT	17
31	052068	BAR-CLUTCH ARM,SILVER	1
32	024077	MTR,DC-24V.,500HP,1200RPM	1
33	024082	ASM,BRUSH-	2
34	027177	BRG,BALL--.669ID,1.575OD.,.472W	2
35	049387	CLAMP-MOTOR MOUNT	2

made DuraFlex
 1/2" x 24" 46-240
 sleeved Belt

DET	PART NO.	DESCRIPTION	QUANT.
36	025253	ASM,WIRE-6GA,BLK,25.0L,RINGS	1
37	025252	ASM,WIRE-6GA,RED,18.0L,RINGS	1
38	003245	SCR CAP HEX HD .312-18X.875L	4
39	049386	BRACKET-PIVOT	2
40	040673	KEY,SQUARE--.187 SQ,1.000 LONG	2
41	049380	SPROCKET,CHAIN--#35,375P,11T	1
42	049382	JACKSHAFT	1
43	048143	CHAIN,ROLLER--#35,69LK & CONN	1
44	004218	WSHR FLT .344ID.750OD.060T STL	8
45	027198	BRG,W/PB--.750ID,CAST IRON	4
46	002443	SCR CAP HEX HD .312-18X1.50L	6
47	049469	KEY,SQUARE--.187 SQ,1.370 LONG	2
48	051194	WHEEL-8.00DIA.,750 BORE	2
49	051162	Performa Tread	2
49	002244	SCR SET CUP PT .250-20X.625L	2
50	053758	SPACER,STEEL--.760ID,1.00OD	1
51	041153	DIFFERENTIAL (Pre 1990)	1
51	053403	SPROCKET,CHAIN--#35,54T(MACH)	1
52	001497	SCR MACH RD HD 6-32X1.50L	2
53	004249	WSHR LK .150ID.320OD.022T EXT	2
54	003327	NUT,HEX LOCK--.375-24,NYLOC	1
55	004384	WSHR FLT .406ID.875OD.064T STL	1
56	050362	SPACER,STL--.375X.625,.260L	1
57	052055	ASM,LIFT-BRUSH,ARM,RIGHT,SLVR	1
58	052053	ASM,BAR-RETRACTING,SILVER	2
59	001289	SCR MACH RD HD 10-24X.500L	2
60	025051	ASM,CABLE-6GA,W/PLUG.35IN	1
60	026573	CHARGER PLUG	1
61	050360	BRACKET-MOTOR STOP	1
62	001244	SCR MACH RD HD 6-32X.750L	2
63	004250	WSHR LK .148ID.250OD.031TSPLT	2
64	003274	NUT,HEX-- 6-32,ZN PLT	2
65	033099	ASM,BRACKET-STOP, MOTOR	1
66	004253	WSHR LK .204ID.410OD.025T EXT	1
67	003279	NUT,HEX-- 10-24,ZN PLT	1
68	052054	ASM,LIFT_BRUSH,BAR,LEFT,SILVR	1

11 51 C54270 Differential (POST-1990)

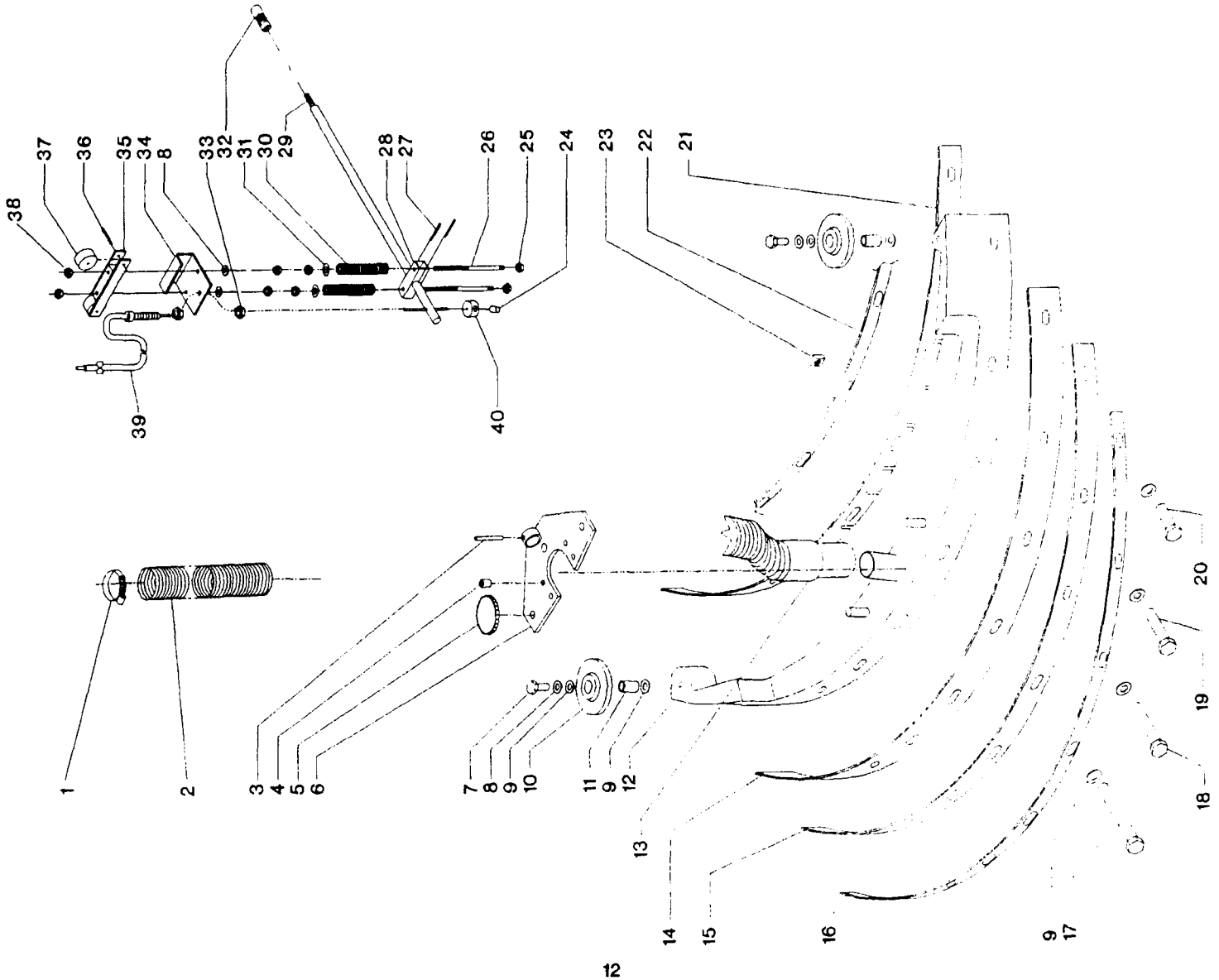

DET	PART NO.	DESCRIPTION	QUANT
1	046688	CLAMP, HOSE-1.75 MAX DIA, WORM	1
2	049444	HOSE-SQUEEGEE	1
3	044839	PIN, ROLL--250 DIA, 1.375L	1
4	002438	SCR SET CUP PT .375-16X.500L	4
5	047484	KNOB	2
6	034377	WDMT, BRACKET-SQUEEGEE, MTG	1
7	003246	SCR CAP HEX HD .312-18X1.00L	2
8	004212	WSHR LK .326ID, 586OD, 078T SPLT	4
9	004218	WSHR FLT .344ID, 750OD, 060T STL	12
10	053720	WHEEL-4.00DIA, 438BORE, .688HB	2
11	053699	SPACER, STL--312X.437, .43L	2
12	054790	CASTING, SQUEEGEE--20 AUTO	1
13	706704	CUFF-HOSE SAME AS 16425	1
14	054794	RUBBER, SQUEEGEE--REAR, 20 AUTO	1
15	054795	RUBBER, SQUEEGEE--BACKUP, 20 AUTO	1
16	054797	BAR, STL--125X1.00, 28.41L, REAR	1
17	001500	SCR CAP HEX HD .250-20X3.50L	2
18	002456	SCR CAP HEX HD .250-20X3.00L	2
19	002455	SCR CAP HEX HD .250-20X2.50L	2
20	002454	SCR CAP HEX HD .250-20X1.50L	2
21	054793	RUBBER, SQUEEGEE-FRONT, 20 AUTO	1
22	054796	BAR, STL--125X1.00, 26.15L, FRON	1
23	005591	NUT, SELF RETAINING--250-20	8
24	002440	SCR SET H/DG PT .250-20X.375L	1
25	003378	NUT, HEX LOCK--312-18, ZN PLT	2
26	050465	STUD--312-18X5.56	2
27	004364	PIN, ROLL--125 DIA, 1.000L	2
28	052064	TUBE, STL, RECT--750X.750, 2.50L	1
29	048552	ROD-SQUEEGEE	1
30	049692	SPRING, COMP .562D 3.38L .071WD	2
31	005374	WSHR FLT .344ID, 687OD, 080T STL	2
32	049473	BALL JOINT BODY	1
33	003437	NUT, HEX JAM .500-20, SS	2
34	053550	BRACKET, STL--125, FORMED, SILVR	1
35	033641	ASM, ROLLER & BRACKET--	1
36	052051	WDMT, ROLLER BRACKET, SILVER	1
37	005474	PIN, ROLL--187 DIA, 1.375L	2
38	053384	WHEEL--1.25DIA, 200BORE, .531HB	2
39	003356	NUT, HEX JAM--312-18, ZN PLT	6
40	034112	WDMT, CABLE-SQUEEGEE, 20IN AUTO	1
40	053613	COLLAR, BRASS--1.00OD, .156ID, .5W	1

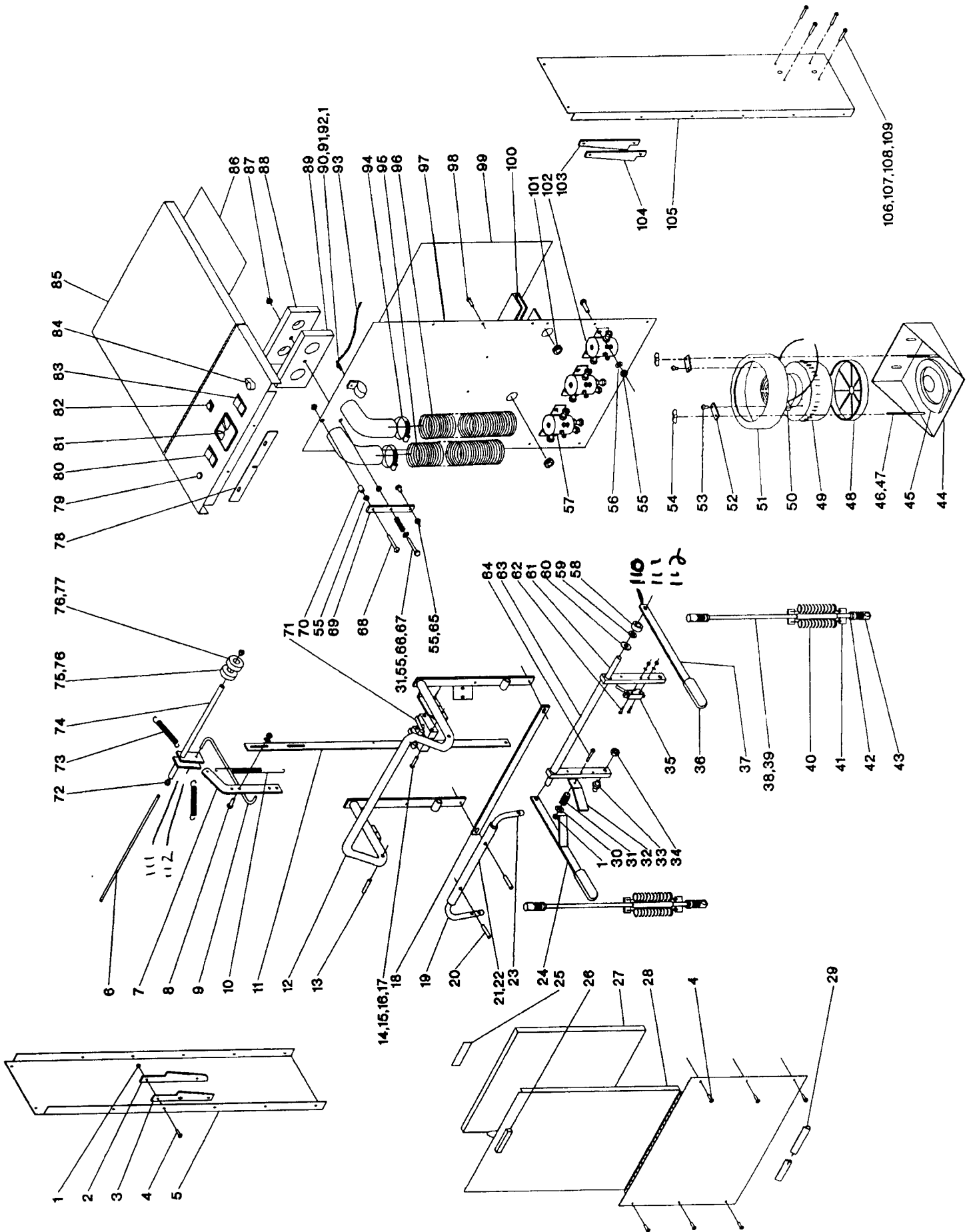

DET PART NO.	DESCRIPTION	QUANT.
94	CLAMP,HOSE--1.75 MAX DIA,WORM	3
95	HOSE-VAC	1
96	HOSE-SQUEEGEE	1
97	WDMT,PANEL--BACK,SST,20"AUTO	1
98	SCR MACH PAN HD 10-24X.750L	2
99	LABEL,INSTR-MAINT,AUTO BAT	1
100	INSULATION STRIP-BACK PANEL	1
101	GROM--1.00 ID,1.25 MHD,.062 PA	2
102	SOLENOID	1
103	NYLON GUARD-SQUEEGEE LOCK	1
104	SQUEEGEE UP LOCK,SILVER	1
105	COLLAR PANEL	1
106	SCR MACH PAN HD 10-32X1.00L	4
107	SPACER,PHEN--250X.437, .250L	4
108	WSHR LK .204ID.410OD.025T EXT	4
109	NUT,HEX-- 10-32,ZN PLT	4
110	Pin, Clevis	
111	Washer, flkt	
112	Cotter pin	

DET PART NO.	DESCRIPTION	QUANT.
47	NUT,HEX LOCK-- 10-24,ZN PLT	2
48	LINT FILTER	1
49	MTR,VAC--24V,BYP,2 STG,PD	1
50	BRUSH,MTR--24 MOD,36V DC VAC	2
51	CAP,MOTOR-MOD.,UJB-880	1
52	BAR,STL--125X.500X1.43 L	2
53	SCR TPG F PAN HD 10-24X.375L	2
54	NUT,WING-- 10-24,ZN PLT	2
55	NUT,HEX--250-20,ZN PLT	10
56	WSHR LK .267ID.510OD.028T EXT	6
57	SOLENOID--24V	2
58	RING-SPACER	1
59	WSHR FLT .531ID1.00OD.071T STL	2
60	WSHR SPR TNSN .531ID.880OD.030	2
61	SHAFT-BRUSH LIFT	1
62	SCR MACH RD HD 6-32X1.25L	2
63	ASM,TUBE--TORQUE,SILVER	1
64	SCR MACH RD HD 10-24X1.50L	1
65	SCR CAP HEX HD .250-20X.375L	1
66	SCR CAP HEX HD .250-20X1.50L	1
67	WSHR FLT .281ID.625OD.062T STL	1
68	SCR CAP HEX HD .250-20X1.00L	1
69	STRAP-TANK SEAL HOUSING,SILVER	1
70	SPACER,STL--272X.380, .380L,Z	2
71	SWITCH,PUSH--SPDT,20A,125-250V	1
72	BRG,FLANGE--250IDX.375ODX.37W	2
73	SPRING,EXT .250D 2.00L .024WD	2
74	WDMT,CLUTCH ACTUATOR--KA201B	1
75	CAM-W/FLAT,1.25 DIA X .37 THK	1
76	SCR SET CUP PT 10-24X.250L	2
77	CAM--W/GRV,1.25 DIA X .37 THK	1
78	BAR-DOOR LOCK,SILVER	1
79	BUTTON PLUG	1
80	SWITCH,RKR--SPST,10A,250V,3/4H	1
81	VOLTMETER	1
82	ASM,LIGHT--INDICATOR,RED	1
83	SWITCH,RKR--SPST,10A,250V,3/4H	1
84	KNOB-WATER CONTROL	1
85	ASM,COVER--TANK	1
86	LABEL,INSTR--MAINTENANCE SCHED	1
87	NUT,HEX LOCK--250-20,ZN PLT	1
88	SEAL-TANK	1
89	HOUSING,SEAL--TANK,SST,20"	1
90	BOLT,EYE-- 10-24X1.00 SHANK	1
91	HOOK,CHAIN,S--.080 DIA WIRE	1
92	CLAMP-ELECTRIC WIRE USE 47488	1
93	CHAIN,WELDESS--33.50L,RS98349	1

DET PART NO.	DESCRIPTION	QUANT.
1	NUT,HEX LOCK-- 10-24,NYLOC	13
2	NYLON GUARD-BRUSH LOCK	1
3	PLATE,BRUSH LEVEL PSNR--SILVER	1
4	SCR MACH PAN HD 10-24X.500L	16
5	COLLAR PANEL	1
6	ROD-CLUTCH SHAFT	1
7	UPPER BAR-CLUTCH ADJ.,SILVER	1
8	SCR CAP HEX HD .250-20X.625L	2
9	LINK-CLUTCH LEVER	1
10	SPRING,EXT .312D 7.38L .035WD	1
11	BAR,STL--125X.750X.26.75 LONG	1
12	ASM,HANDLE--SQUEEGEE BAR	1
13	PIN,ROLL--187 DIA,1.375L	2
14	SCR MACH RD HD 6-32X1.75L	2
15	WSHR FLT .156ID.375OD.065T STL	2
16	WSHR LK .150ID.320OD.022T EXT	4
17	NUT,HEX-- 6-32,ZN PLT	4
18	STOP BAR-BRUSH LIFT,SILVER	1
19	TRACTION BAR-LEFT	1
20	PIN,ROLL--187 DIA, .860L	2
21	HANDLE-TRACTION BAR	1
22	ASM,BAR--TRACTION,UJB880	1
23	TRACTION BAR-RIGHT	1
24	WDMT,HANDLE--BRUSH,SILVER,KA20	1
24	LABEL,INSTR--BRUSH LEVER	1
25	LABEL-CLEAN VAC FAN	1
26	TEE LATCH	1
26	049366	
27	CARPET-REAR ACCESS DOOR	1
28	ASM,DOOR--REAR	1
29	U-CHNL,PLSTC--RS 98251, 7.62 L	1
30	WSHR FLT .203ID.562OD.045T STL	1
31	SPRING,COMP .480D .875L .063WD	2
32	BAR,STL--125X1.00X4.21L,FORMD	1
33	BALL JOINT	4
34	NUT,HEX LOCK--375-24,NYLOC	2
35	SWITCH,PUSH--RS 26603,MODIFIED	1
36	GRIP,HANDLE	2
37	LABEL,INSTR--OPN,SUCEUR SQUEEG	1
37	LIFT HANDLE-SQUEEGEE,SILVER	1
38	ASM,ROD--ADJ,BRUSH LIFT,W/SPRG	2
39	WDMT,ADJ ROD--ROD END	2
40	SPRING,EXT .500D 3.50L .063WD	4
41	WDMT,ADJ ROD--SLEEVE END	2
42	NUT,HEX--375-24,ZN PLT	4
43	BALL JOINT BODY	4
44	WDMT,VAC--TUBE/BRACKET,SST 20	1
45	GASKET-VAC MOTOR	1
46	ROD,STL,THRD--10-24X4.50 LONG	2

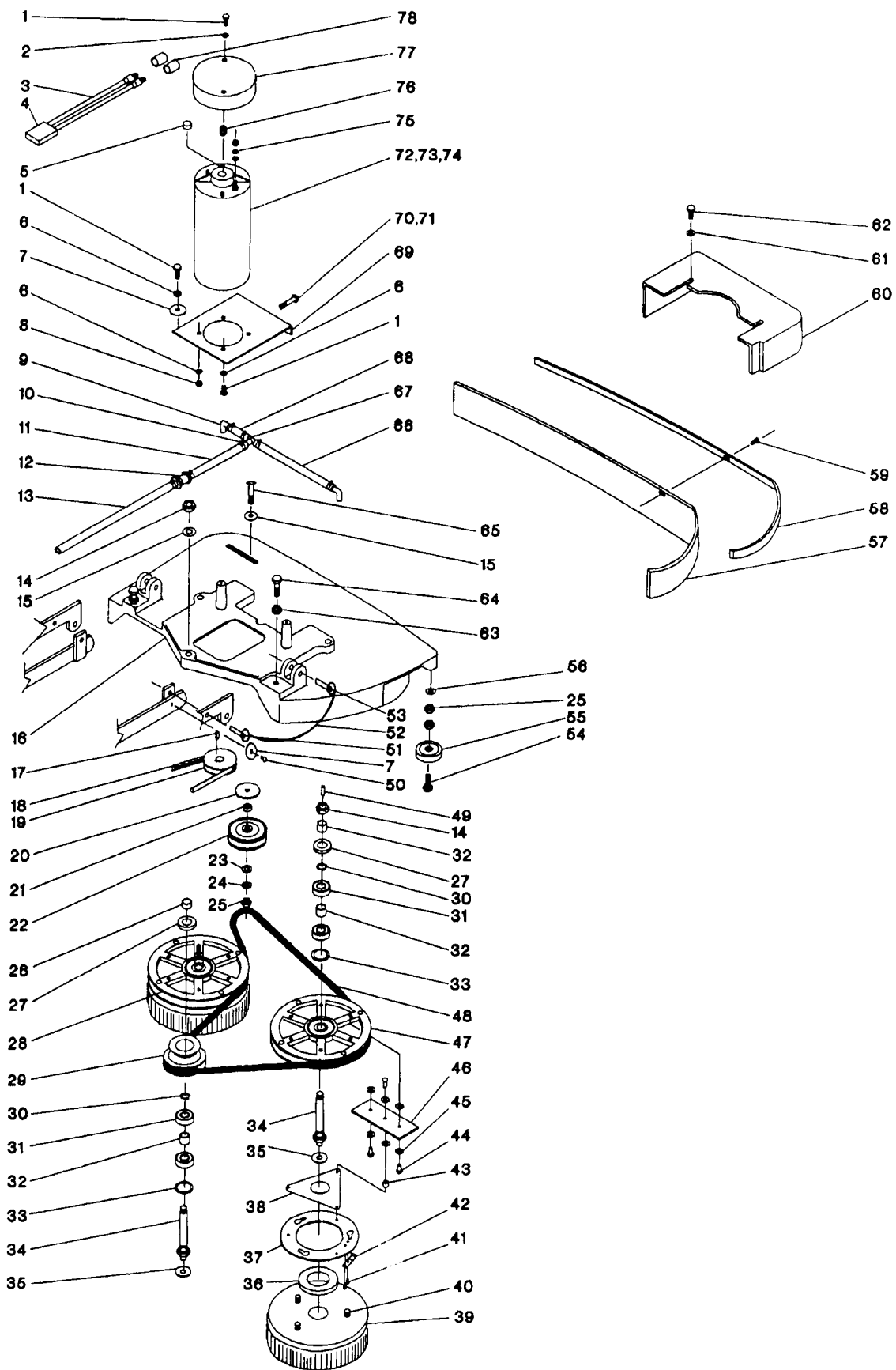

DET	PART NO.	DESCRIPTION	QUANT.
1	003244	SCR CAP HEX HD .312-18X.750L	6
2	053293	WASHER, SEALING-- .312 DIA, KA201	2
3	025052	ASM, CABLE--6GA, W/PLUG, 18IN	1
4	026573	CHARGER PLUG 36V	1
5	050113	PLUG-MOTOR	1
6	004444	WSHR LK .332ID.610OD.034T EXT	6
7	004427	WSHR FLT .344ID1.25OD.120T STL	4
8	003349	NUT, HEX-- .312-18, ZN PLT	2
9	046946	ELBOW, HOSE--3/8X3/8, PLSTC	2
10	051581	CLAMP, HOSE-- .625 MAX DIA, WORM	8
11	033440	ASM, SOLUTION LINE-W/QK. DISCON.	1
11	046950	TUBE, VINYL-- .375X.562, 6.00L	1
12	049462	QUICK DISCONNECT	1
13	049395	TUBE, VINYL-- .375, .562, 12.00L	1
14	003367	NUT, HEX LOCK-- .500-20, ZN PLT	3
15	004238	WSHR FLT .531ID1.00OD.071T STL	2
16	053555	HEAD, BRUSH--MACHINED, 20IN BAT	1
17	049017	KEY, WOODRUFF--#606, .750D, .187W	1
18	049402	BELT, V--4L, 17.00 PITCH LENGTH	1
19	049403	SHEAVE-MOTOR	1
20	004374	WSHR FLT .406ID1.75OD.060T STL	1
21	048352	SPACER, STL-- .380X.625, .310L, Z	1
22	053409	ASM, PULLEY & BRG--BRUSH HEAD	1
23	004225	WSHR FLT .406ID1.00OD.036T STL	3
24	004214	WSHR LK .390ID.683OD.094TSPLT	1
25	003294	NUT, HEX JAM-- .375-16, ZN PLT	3
26	048608	SPACER, STL-- .594X.750, .375L, Z	1
27	027218	SHAFT SEAL	1
28	032659	ASM, PULLEY--BRUSH DRV, LEFT, 20	1
28	032670	ASM, PULLEY & BRUSH DRIVE RING--L	1
29	038914	ASM, PULLEY--STEP FOR 20IN AUTO	1
29	049404	PULLEY, CONE--4L, 3.00-2.40PD	1
30	048587	RING, RTNG--INT, 1.37 CYL, N5000	3
31	027188	BRG, BALL-- .591ID, 1.378OD, .433W	6
32	048566	SPACER, STL-- .598X.750, .610L, Z	5
33	224021	WSHR FLT 1.06ID1.37OD.015T STL	3
34	048565	SHAFT-BRUSH DRIVE	5
35	050364	WSHR FLT .430ID1.20OD.143T RUB	3
36	046764	BRUSH SUPPORT	2
37	032231	ASM, DRIVE--BRUSH, RIGHT	1
37	032232	ASM, DRIVE--BRUSH, LEFT RING	1
38	048414	PLATE-BRUSH RING SUPPORT	2

DET	PART NO.	DESCRIPTION	QUANT.
39	020257	BRUSH, FLAT--10.5OD, BASSINE, WD	2
40	046746	BRUSH LUG	6
41	004328	RIVET, TUBE-- .141 DIA, .281L	4
42	046898	SPRING-RETAINING	2
43	046425	SPACER, PHEN-- .250X.437, .250L	6
44	004326	RIVET, TUBE-- .250 DIA, .719L	18
45	004513	WSHR FLT .281 ID.875OD.036T ZN	36
46	049631	STRAP-BRUSH RING	6
47	032660	ASM, PULLEY--BRUSH DRV, RIGHT, 20	1
47	032669	ASM, PULLEY & BRUSH DRIVE RING--R	1
48	049535	BELT, DOUBLE-V--	1
49	046952	WATER TUBE-ROLL PIN	2
50	002371	SCR TPG F PAN HD 10-24X.625L	2
51	050356	PIN, QUICK RLSE-- .312 DIA, .625L	2
52	033103	ASM, PIN--SLIDE LOCK	2
52	047604	CABLE, LIFT	2
53	051560	PIN, QUICK RLSE-- .375 DIA, 1.40L	2
54	002332	SCR CAP HEX HD .375-16X1.75L	1
55	049478	WHEEL--RS 46986 W/.380 BORE	1
56	004215	WSHR LK .398ID.694OD.040T EXT	1
57	049957	SPLASHGUARD	1
58	049958	MOUNTING STRAP-SPLASHGUARD	1
59	002371	SCR TPG F PAN HD 10-24X.625L	7
60	049960	COVER-BRUSH HEAD	1
61	004218	WSHR FLT .344ID.750OD.060T STL	2
62	002253	SCR CAP HEX HD .250-20X.750L	2
63	003438	NUT, HEX JAM-- .375-16, SST	2
64	001419	SCR CAP HEX HD .375-16X1.25L	2
65	002347	BOLT, SQ NECK-- .375-16X2.00L	1
66	049475	TUBE, VINYL-- .375X.625, 8.00L	1
67	046944	TEE, HOSE--3/8X3/8X3/8, PLSTC	1
68	047671	TUBE, VINYL-- .375X.562, 2.00L	1
69	049398	MOTOR PLATE	1
70	003215	SCR MACH RD HD .312-18X2.00L	1
71	003289	NUT, WING-- .312-18, ZN PLT	1
72	024077	MTR, DC--24V, 500HP, 1200RPM	1
73	024082	ASM, BRUSH--	2
74	027177	BRG, BALL-- .669ID, 1.575OD, .472W	2
75	004254	WSHR LK .267ID.510OD.028T EXT	4
76	053290	STAND OFF-THRD, .312-18X.075L	2
77	053294	COVER, MOTOR--MACHINED, KA-201	1
78	048607	TUBE, VINYL-- .500X.750, 1.50L	2

HEAD ASM:

0.5 hp 032999

0.75 hp 034788

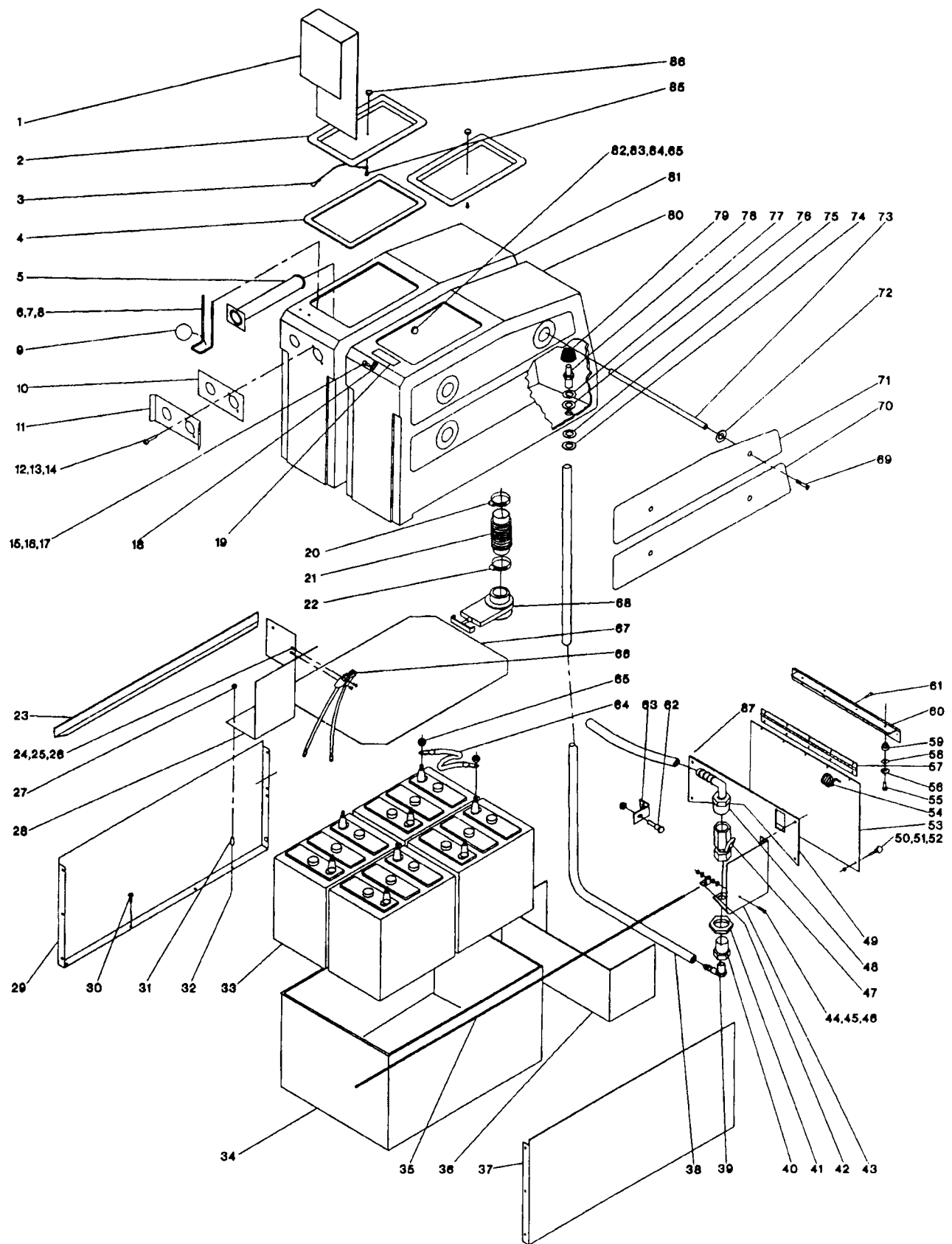

DET	PART NO.	DESCRIPTION	QUANT.
1	050879	BAFFLE-TANK	1
2	049390	LID-TANK	2
3	053547	WIRE ROPE--.062 DIA. X 20.0L	2
4	049443	GASKET-LID	1
5	032447	ASM,TUBE--INLET,RECOVERY	1
6	049917	CAGE-BALL FLOAT	1
7	004253	WSHR LK .204ID.410OD.025T EXT	1
8	003279	NUT,HEX-- 10-24,ZN PLT	1
9	049388	BALL-FLOAT	1
10	052557	GASKET,FOAM--.125X3.00X6.18	1
11	052558	SHEET,STL--FORMED,GUIDE,KA201B	1
12	001257	SCR MACH FLAT HD 8-32X.875L	2
13	004252	WSHR LK .176ID.381OD.023T EXT	2
14	003276	NUT,HEX-- 8-32,ZN PLT	2
15	002256	SCR CAP HEX HD .250-20X1.00L	1
16	005373	WSHR FLT .281ID.625OD.062T STL	1
17	003283	NUT,HEX--.250-20,ZN PLT	1
18	049453	BRACKET-MOUNTING	1
19	047080	LABEL,INSTR--OPN,FILL HERE	1
20	044112	CLAMP,HOSE--2.50 MAX DIA,WORM	1
21	048698	HOSE,RBR,FLEX-- 8.00L,1.87 DIA	1
22	049999	CLAMP,HOSE--2.25 MAX DIA,WORM	1
23	050485	TRIM STRIP	2
24	001244	SCR MACH RD HD 6-32X.750L	2
25	004250	WSHR LK .148ID.250OD.031TSPLT	2
26	003274	NUT,HEX-- 6-32,ZN PLT	2
27	005480	NUT,HEX LOCK-- 10-24,NYLOC	5
28	051876	BRACKET,HOSE--SST,20" AUTO	1
29	050481	SIDE PANEL LEFT	1
30	005487	SCR TPG F PAN HD 10-24X.500L	6
31	050908	SPACER,STL--.250X.375,1.562L,Z	1
32	223044	SCR MACH RD HD 10-24X2.00L	1
33	026408	BATTERY-- 6V,200AH,WET	4
33	026441	BATTERY-- 6V,200AH,DRY	4
34	053538	BOX,BATT--20" AUTO'S,MACHINED	1
35	033266	ASM,CABLE--WATER CONTROL	1
36	050457	STL SHEET--FORMED,16 GA SS	1
37	050479	SIDE PANEL RIGHT	1
38	049395	TUBE,VINYL--.375,.562,12.00L	2
39	049381	ELBOW,PP-HS--1/4 MPTX3/8HS,PLS	1
40	006104	BSHG,PIPE--1/2 MPTX1/4 IPT,BRS	1
41	006108	NUT,SPECIAL--.500 PIPE,HEX LOC	1
42	042113	CLAMP,LOOP--.187 DIA,STL	1
43	051871	BRACKET,WATER VALVE--SST,20"	1
44	005456	SCR MACH PAN HD 10-24X.500L	1
45	005297	WSHR LK .200ID.334OD.047TSPLT	2
46	003279	NUT,HEX-- 10-24,ZN PLT	2
47	049391	WATER VALVE	1
48	049436	ELBOW 90 DEG PVC	1

5 ~~053246~~ Gasket, foam - Inlet tube

DET	PART NO.	DESCRIPTION	QUANT.
49	051874	BRACE,FRONT--SST,20" BTTRYAUTO	1
50	002385	SCR--SOUTHCO 12-12-204-11,WING	2
51	004467	WSHR PNL FSTNR SCR SOUTHCO	2
52	003410	NUT,SPEED,U--.250 NOM,.50X1.01	2
53	033581	ASM,PANEL--FRONT,SST,20" AUTO	1
53	051870	DOOR,ACCESS--BRUSH HEAD,SST	1
54	053171	SPRING,TRSN 1.12D .625L .125WD	1
55	002243	SCR CAP HEX HD .250-20X.625L	10
56	002278	WSHR LK .262ID.489OD.062TSPLT	4
57	033960	WDMT,HINGE--W/SPRING RETAINERS	1
58	004462	WSHR FLT .250ID1.00OD.062T STL	4
59	111287	BUSHING-RUBBER	4
60	033566	WDMT,HINGE--TANK COVER,KA20SST	1
61	004440	RIVET,TUBE--.123 DIA,.187L	10
62	044826	CONNECTOR-WATER VALVE CABLE	1
63	049435	LEVER-WATER VALVE	1
64	025085	ASM,WIRE-- 6GA,BLK,10.2L,RINGS	3
65	003349	NUT,HEX--.312-18,ZN PLT	8
66	026573	CHARGER PLUG	1
66	033053	ASM,SUB-CHARGER,PLUG	1
66	6726074	Charger Plug 24V	
67	046996	BATTERY COVER	1
68	050504	VALVE-SLIDE	1
69	002264	SCR MACH FLAT HD .250-20X1.25L	8
70	048035	COVER PANEL LOW LEFT TANK	1
70	048036	COVER PANEL LOW RIGHT TANK	1
70	048794	LABEL,IDENT--KENT,4.00X23.00	1
70	048795	LABEL,IDENT--KENT LOW-LH TANK	1
71	048033	COVER PANEL UP RIGHT TANK	1
71	048034	COVER PANEL-UPPER LEFT TANK	1
71	048796	LABEL,IDENT--TANK UPPER RIGHT	1
71	048797	LABEL,IDENT--TANK UPPER LEFT	1
72	004437	WSHR FLT .656ID1.87OD.100T STL	8
73	048038	RD,STL--.500DIA,12.87L	4
74	006114	NUT,HEX LOCK--.750 IPT,CONDUIT	1
75	004330	WSHR FLT 1.05ID1.50OD.036T STL	1
76	046980	ASM,GASKET--SCREEN	1
77	004472	WSHR FLT 1.08ID2.06OD W/FLAT	1
78	051235	ADPTR,HS-BS--3/8HOSEX.500 BOSS	1
79	048848	LINE STRAINER	1
80	032824	ASM,TANK--SOLUTION	1
80	049394	SOLUTION TANK-MACHINED	1
81	032825	ASM,TANK--RECOVERY	1
81	049393	TANK-RECOVERY	1
82	003244	SCR CAP HEX HD .312-18X.750L	1
83	004218	WSHR FLT .344ID.750OD.060T STL	1
84	004212	WSHR LK .326ID.586OD.078TSPLT	1
85	005316	SCR TPG F PAN HD 10-24X.375L	2
86	048022	KNOB	2

87 026515 Switch 21A, 240V

THE KENT LIMITED WARRANTY

Your Kent equipment which has been manufactured, tested, and inspected in accordance with carefully specified engineering requirements, is warranted to be free from defects in material and workmanship. This warranty is, however, subject to the following qualifications, conditions, and limitations which are set forth to provide you and all users of the equipment with information concerning the duration, extent, availability, and applicability of the Kent limited warranty, the procedure to be taken to obtain its performance, and other information concerning the Kent warranty policy.

The Kent Limited Warranty is extended to the original end user as follows

Automatic scrubber vacs (excluding the KA33BR) and all battery operated burnishers carry a three year parts replacement and one year labor warranty. Batteries are warranted on a prorated basis for one year. Battery chargers are warranted by the manufacturer for one year. Propane engines are warranted by the manufacturer for a period of two years (one year on the valve train) for Briggs & Stratton engines, and 3 years on Onan engines.

Replacement parts are covered for the remainder of the machines warranty or 90 days, whichever is longer.

All sweepers, all pressure washers, all propane burnishers, and the KA33BR have a one year parts and labor warranty.

Poly components carry a ten year replacement warranty with one year service labor. This warranty will not cover damage attributable to the following:

: Improper, unreasonable or negligent use or abuse of the equipment.

: Use of the equipment with hot water (over 120 deg. F , 49 deg. C).

: "Warpage", "Creepage", or "Distortion" of the part so long as the same does not interfere with normal operation.

: Abrasions or punctures of the equipment.

The start date of the warranty coverage shall be the date the machine was shipped from the factory, or with proof of purchase, the purchase date of the original end user. The start date of the warranty shall not exceed one year from the date that the unit leaves the factory.

Parts of Kent Equipment not covered by the Kent Limited Warranty

Certain parts of Kent Equipment require replacement in the ordinary course of use due to normal wear by reason of their characteristics. These are normal wear items such as cords, squeegee blades, belts, gaskets, bumpers, carbon brushes, filters, hoses, bags, pad holders, brushes etc.

Exceptions and Exclusions from Warranty

Defects, malfunctions, failure, or damage of the equipment caused by improper care, unreasonable or negligent use or abuse of the equipment are excluded from this warranty. If repair is done to the equipment by anyone other than those designated as authorized to perform such work without having obtained factory authorization in writing, the Kent Company at its sole option, may determine that this warranty will not apply and that reimbursement for such repair will not be made because of the failure to comply with such factory instructions.

Procedure to be taken to obtain performance of warranty repair

To secure repair of the equipment or any warranted parts under this warranty, the following procedure must be taken. The inoperative equipment or warranted parts together with satisfactory evidence of the purchase date, must be delivered, with shipping and delivery charges prepaid, to one of the following:

: The dealer from whom purchased.

: Any Kent distributor's service department in the United States.

: Any Kent authorized service station in the united states.

If you are unable to locate any of the foregoing, you may write or otherwise communicate with The Kent Company for instructions before repair service is performed by anyone else. In such event, The Kent Company will provide either the location of a Kent authorised service department or other factory instructions. In the event that no local service department is available, Kent at its discretion will repair or replace the part or equipment at the factory, the products will be returned to the owner freight prepaid. No warranty will be honored without proof of purchase, the model number, and serial number if applicable.

Replacement

In the event of a defect, malfunction, or failure of your Kent equipment or any warranted part to conform with this warranty, The Kent Company may, at its sole option and own expense, replace the equipment or any warranted part with another new identical or reasonably equivalent model or part in lieu of repairing the defect.

No refund of purchase price

The Kent Company will not, as a matter of its warranty policy, refund the customer's purchase price.

Warranty registration

Your Kent Company distributor from whom you purchased your equipment is responsible for the registration of your warranty with the factory. We ask that you cooperate with your distributor in supplying the necessary information on the warranty card so that we may better serve you. Any information or questions that you may have concerning your Kent equipment or this warranty may likewise be secured from the factory. This warranty gives you specific legal rights, and you may also have other rights which vary from state to state.